

PURUS

Digital Panel Heater

PUR400PH-2

PUR1000PH-2

PUR1500PH-2

PUR2000PH-2



Thank you for choosing our PURUS Digital Panel Heater. Please be sure to read this users' manual carefully before using the unit. If you should encounter any problems, please contact a qualified service technician for help.

Contents

Parts List

Technical Information

Safety Instructions

Using your Heater

Maintenance

Warranty

Parts List

No.	Description	No.	Description
1	Back Board	10	Heating Bracket
2	Bracket	11	Heating Element
3	Switch Box	12	Sealing Ring
4	Cable Clamping Board	13	Window
5	Cover	14	Control Panel
6	Switch	15	Front Board
7	Rubber Sleeve	16	Basement
8	Side Board	17	Caster
9	Turnover Switch		

Exploded Assembly Diagram

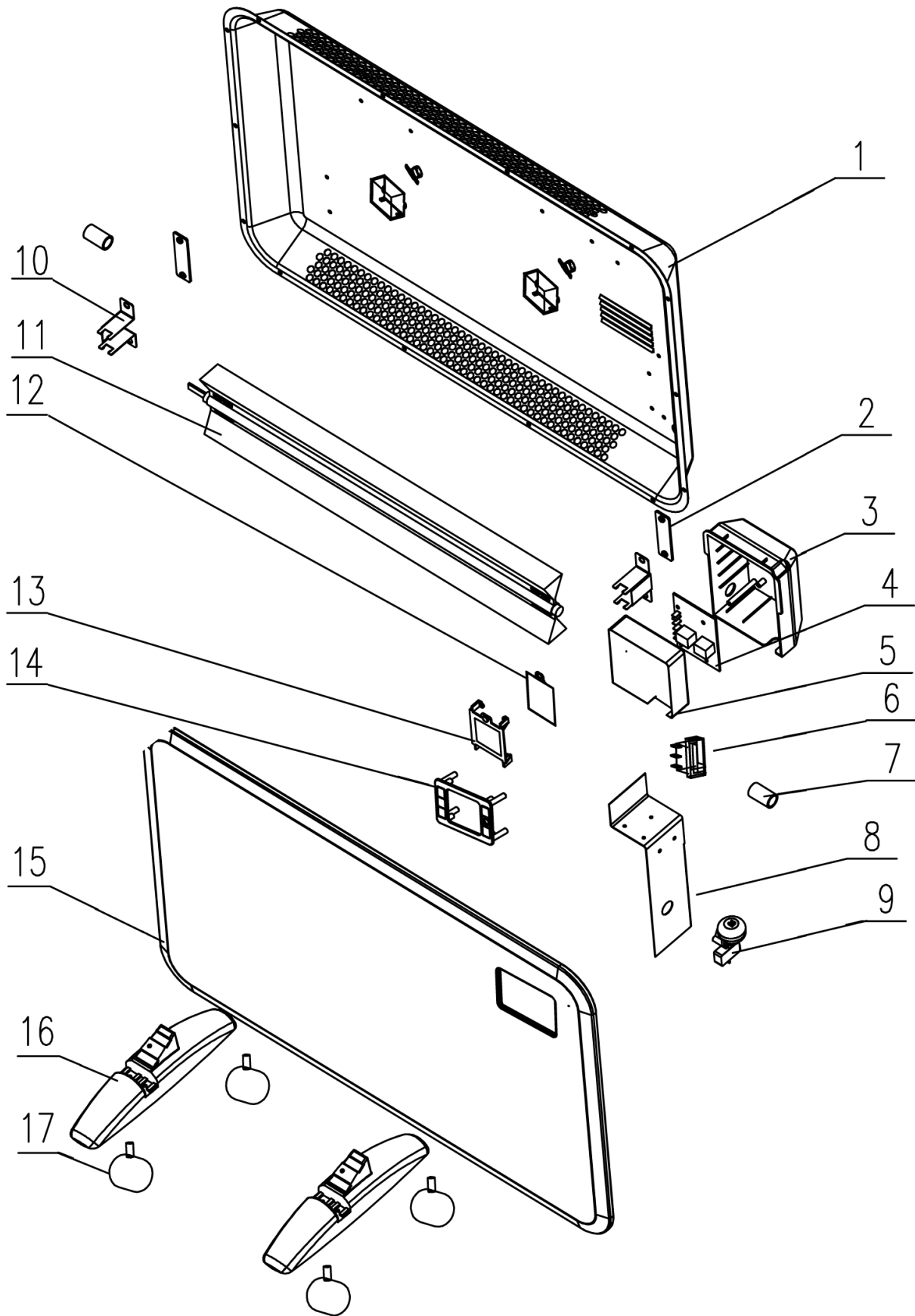

NOTICE: Actual product may vary from pictures shown.

Overview:

1. Control Display panel
2. Front Panel
3. Power Switch
4. Basement
5. Caster
6. Hanging Hook
7. Back Panel

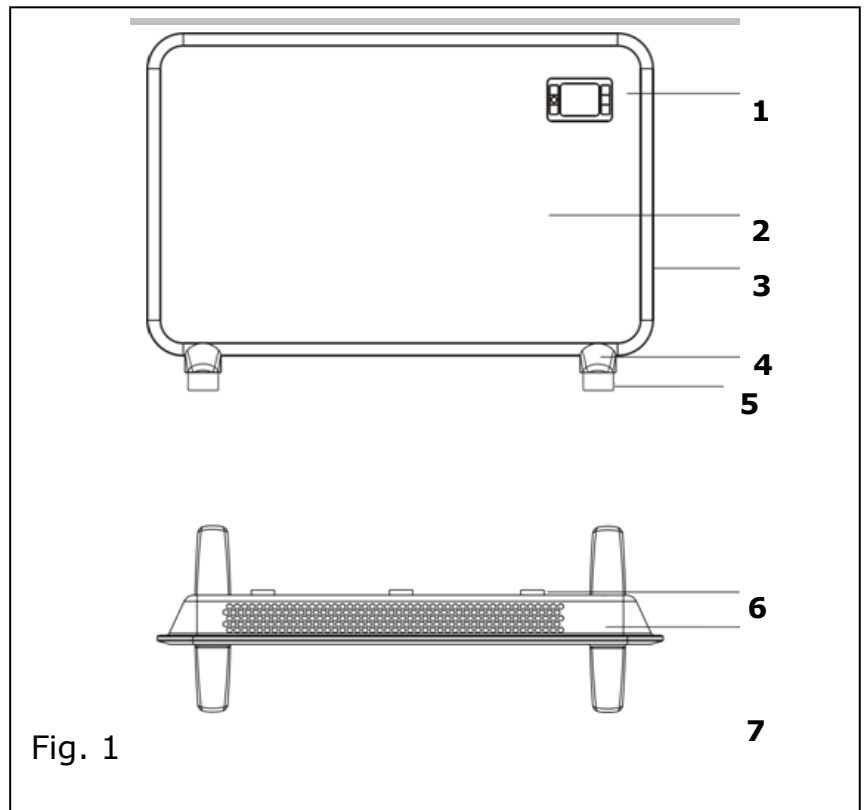

Technical Information

Digital Panel Heater

Model: PUR400PH-2

Voltage: 220V-240V~ /50HZ

Rated Power: 400W

Heat Setting: 200W/ 400W

IP rate: IP24

Model: PUR1000PH-2

Voltage: 220V-240V~ /50HZ

Rated Power: 1000W

Heat Setting: 500W/ 1000W

IP rate: IP24

Model: PUR1500PH-2

Voltage: 220V-240V~ /50HZ

Rated Power: 1500W

Heat Setting: 750W/ 1500W

IP rate: IP24

Model: PUR2000PH-2

Voltage: 220V-240V~ /50HZ

Rated Power: 2000W

Heat Setting: 1000W/ 2000W

IP rate: IP24

IMPORTANT

Read these instructions fully before using the Panel heater. Retain these instructions for future reference.

Important Safeguard Instructions

1. The product is for household use only
2. The item should be used only as intended
3. Check item carefully before use. Do not switch on heater with defects or a damaged cord.
4. Never submerge the heater in water.
5. Only plug the item into an AC power source.
6. The appliance should be connected to the same voltage as stated on the rating label and packaging.
7. The heater should be plugged into an earthed socket.
8. Do not use a non-standard power supply.
9. Before plugging in the heater, make sure that it is switched off.
10. Do not use item outdoors.
11. Protect the product from impact to the corners.
12. Do not touch heater with wet hands.
13. If there is water on the surface of the heater, unplug it immediately.
14. If the heater falls into water, unplug it immediately.
15. Always unplug the item after use, before cleaning or if you find any defects.
16. Never carry the heater by the cord.
17. When you switch off the heater keep your hand on the plug and pull it, do not pull the cord.
18. Do not wrap the cord around the appliance after the use.
19. Flatten the cord when you do not use the heater.
20. The cord can only be changed by a qualified electrician.
21. Only original spare parts can be used for repair.
22. This appliance is not intended for use by persons (including children) with reduced physical, sensory or mental capabilities, or lack of experience and knowledge, unless they have been given supervision or instruction concerning use of the appliance by a person responsible for their safety.

Safety Instructions

1. Check whether or not the local power supply matches the appliance electric rating printed on the label before operation.
2. Children should be supervised to ensure that they do not play with the appliance. If the appliance is damaged, do not use it.
3. Ensure that the socket into which the heater is plugged is in accordance with the rating label on the heater and that the socket is earthed.
4. When the appliance is not in operation, please remove plug from supply mains.
5. The plug must be removed from the socket-outlet before cleaning or maintaining the appliance
6. Don't remove the plug by pulling the power cord.
7. Avoid the use of an extension cable as this may overheat and cause a risk of fire.
8. Keep the mains lead away from the hot body of the heater.
9. **WARNING: In order to avoid overheating, do not cover the heater.**
10. **If the unit is to be fitted in a bathroom it must be installed by a Qualified Electrician.**
11. The device is intended for household use. Do not use outdoors.
12. **Do not cover or obstruct any of the heat outlet grilles or the air intake openings of the heater.**
13. Always ensure that the heater is not positioned close to curtains or furniture as this could create a fire hazard.
14. The heater must not be located immediately below an electrical socket-outlet.
15. Do not insert any object through the heat outlet or air intake grilles of the heater.
16. Do not place this heater near flammable materials, surfaces or substances, as there may be a risk of fire.
17. Particular care should be taken when the heater is situated in areas occupied by children or invalids.
18. Always unplug the heater when moving it.
19. The room which is to be heated should not contain any easy inflammable materials (e.g., petrol, solvents, spray canisters etc.) or other easy combustible materials (e.g., wood or paper). Keep such materials away from equipment. Risk of fire!!
20. Do not operate the heater with a damaged cord or plug, or after the heater malfunctions, has been dropped, or damaged in any manner.
21. If the supply cord is damaged, it must be replaced by the manufacturer or its service agent or a similarly qualified person in order to avoid a hazard.
22. This appliance should not be used by children aged under 18 years and persons with reduced physical, sensory or mental capabilities or lack of experience and knowledge if they have been given supervision or instruction concerning use of the appliance in a safe way and understand the hazards involved. Children shall not play with the appliance. Cleaning and user maintenance shall not be made by children without supervision.
23. Children of less than 3 years should be kept away unless continuously supervised.
24. **CAUTION:** Some parts of this product can become very hot and cause burns. Particular attention has to be given where children and vulnerable people are present.

25. **WARNING:** Do not use this heater in small rooms when they are occupied by persons not capable of leaving the room on their own, unless constant supervision is provided.

Before use

1. Remove the heater carefully from the packaging.
2. Check all the parts are present.
3. Read and understand the user manual.

Installation

The panel heaters can be wall-mounted or floor standing using the feet and castors supplied.

Mounting the Feet (Fig. 2)

Remove the heater and all the accessories from the carton.

1. Turn the heater upside down.
2. Match the three feet holes with the pre-drilled holes at the bottom of the heater.
3. Use the 6 x screws provided to secure the two feet to the heater.
4. Turn the heater the right way up.

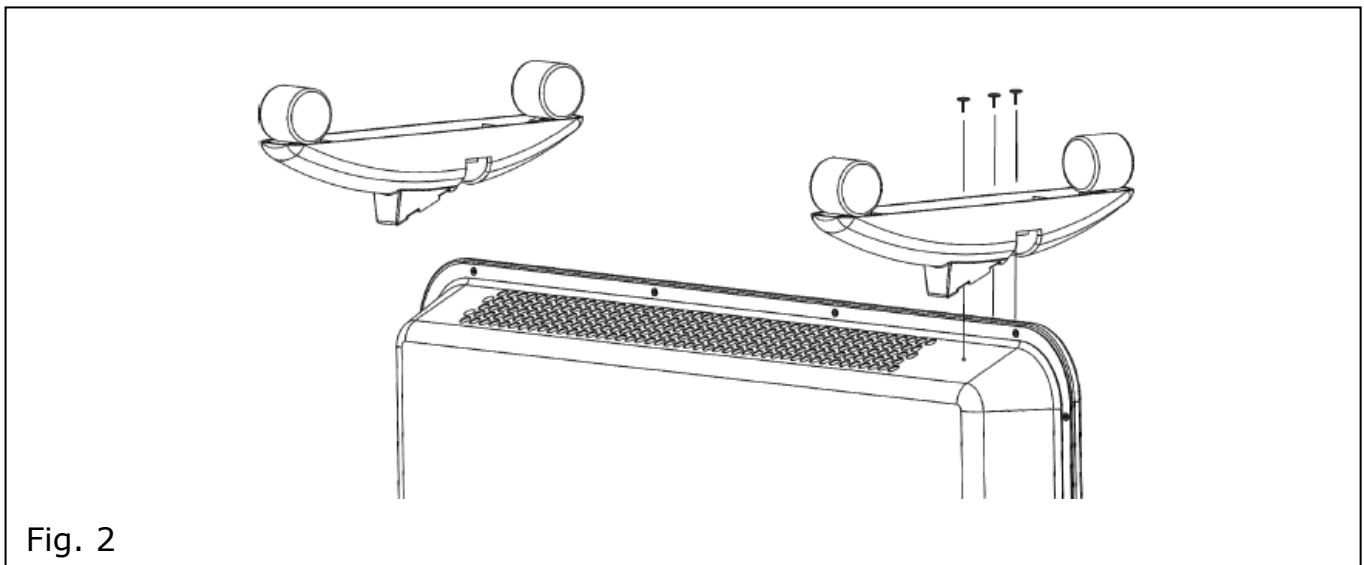

Fig. 2

Wall Mounting (Fig. 3-6)

Note: Before drilling, ensure that there are no wires or pipes in the wall to prevent electric shock or damage to plumbing.

1. Drill two holes with a diameter of 8mm and depth of 40mm on the wall, Ensure the distance of two holes are required. (200mm for 400W; 335mm for 1000W; 405mm for 1500W; 515mm for 2000W.)
2. Then insert the plastic anchors supplied within into the drilled holes.
3. Use a screwdriver to tighten the screws supplied into the plastic anchors, leave the head of the screw protruding from the hole by 6mm.

400W

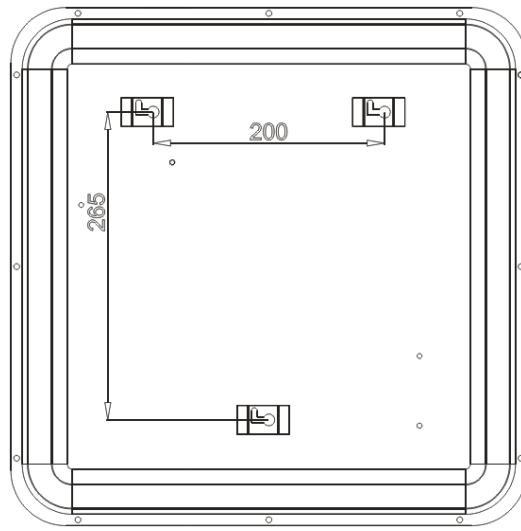

Fig. 3

1000W

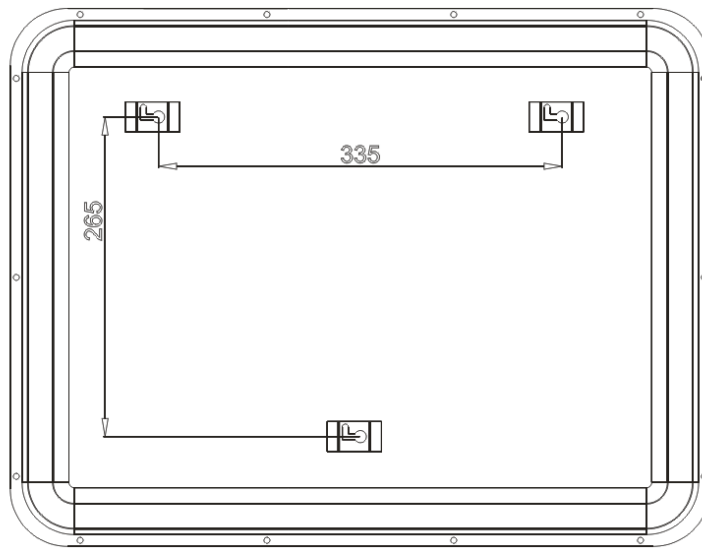

Fig. 4

1500W

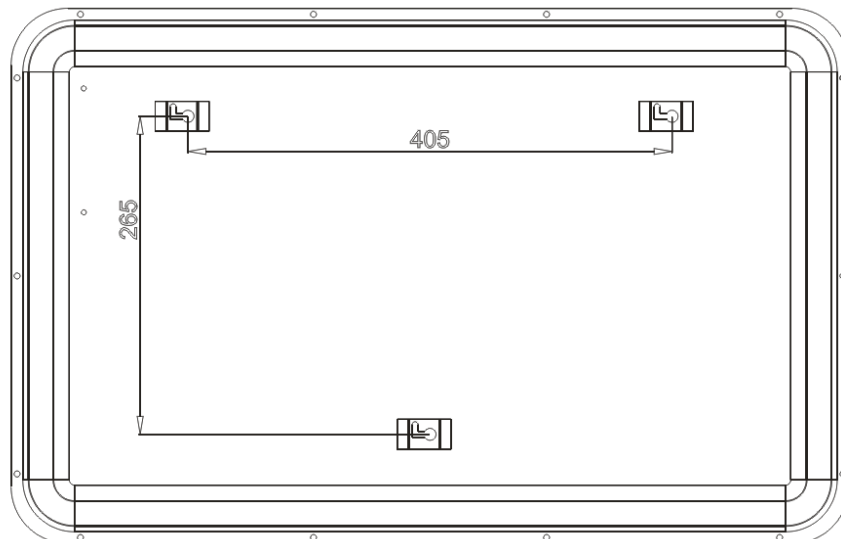

Fig. 5

2000W

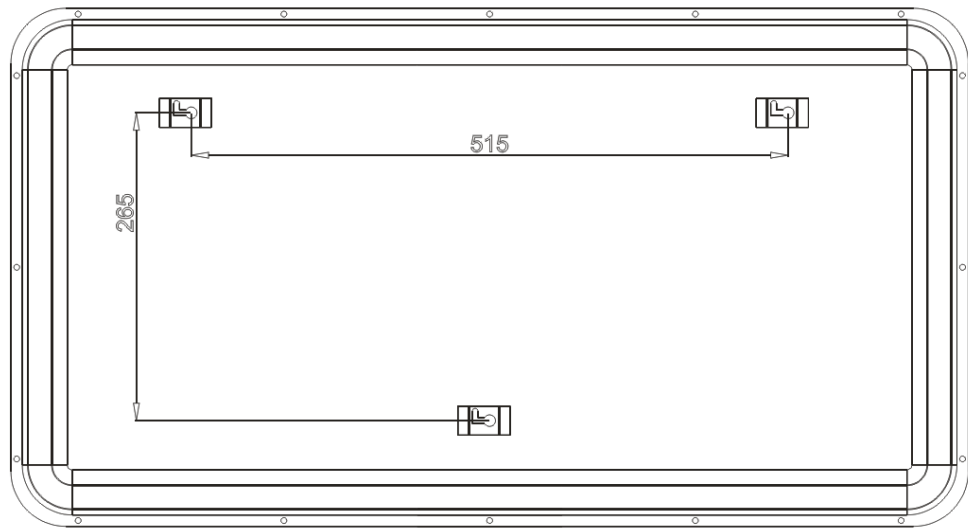

Fig. 6

Using your Heater

1. Place the heater on flat stable surface or mount to the wall as previously shown.
2. Make sure the power switch is in the off position.
3. Plug the heater in.
4. If the appliance is not going to be used for a long time, switch it off with power switch and unplug the heater.
5. **Attention! Do not cover the product when in use!**

Operation Instruction

Control Panel

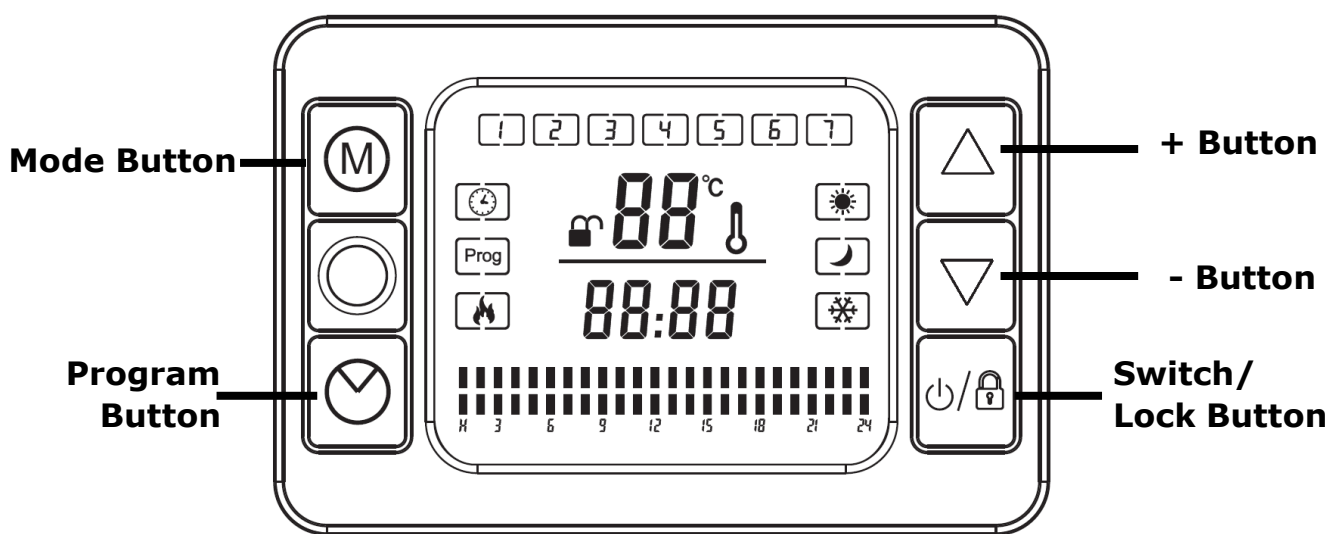
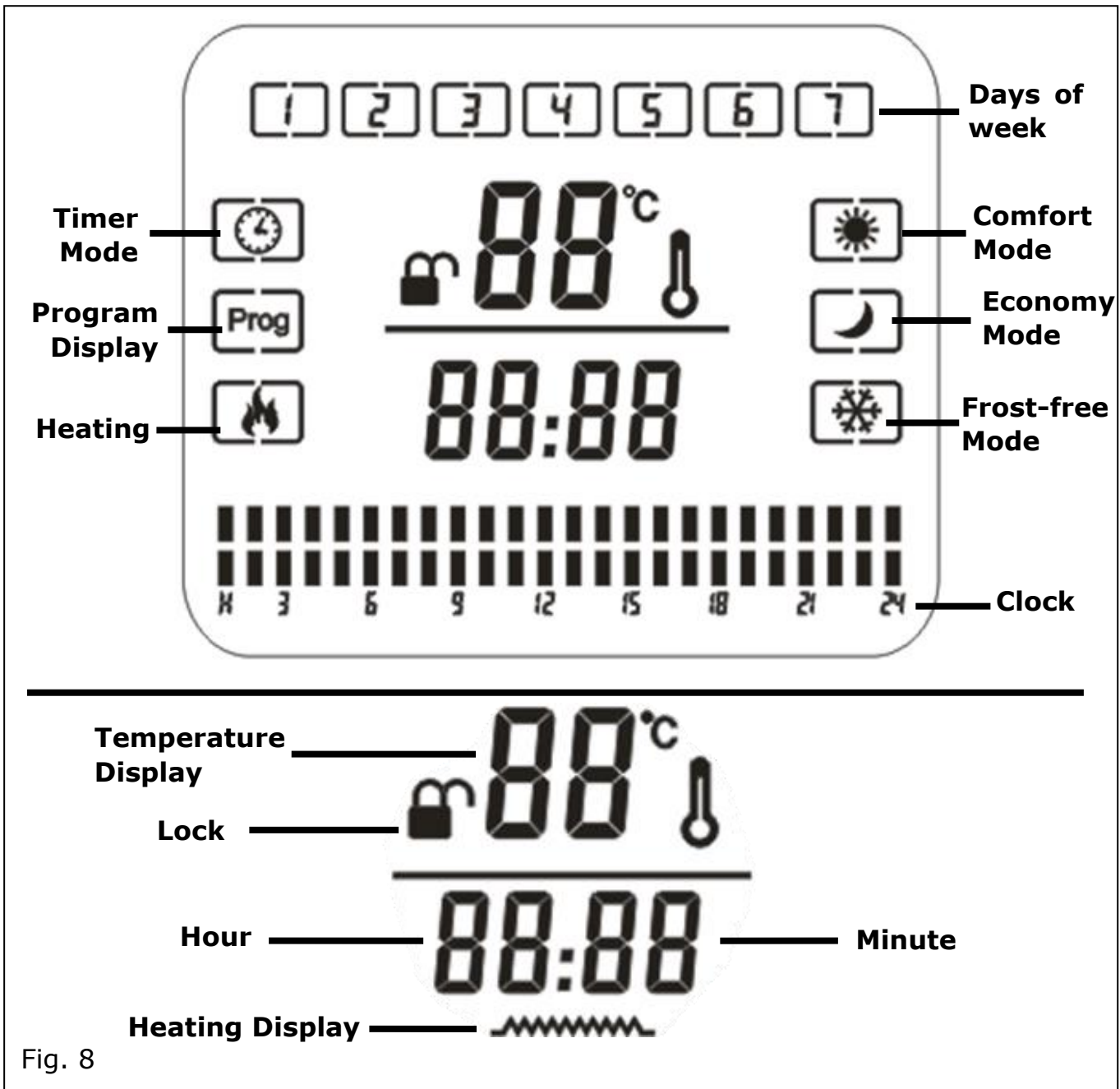

Fig. 7



Display Screen



First Use



Warning! Before using the equipment for the first time, check that the voltage supply is the same as the voltage details set out on the rating label.

Read the safety instructions carefully. When the equipment is used for the first time or after a long period of rest, it may emit an odor for a short time. This is not a fault.



1. Plug in the unit's power plug into a 220-240V AC electrical outlet.
2. The first step when you want to use the appliance is to turn on the Power switch.
3. After the main switch is activated, the equipment will be in standby mode and the screen will light up. The symbol  or  will be shown on the screen. It means that

the child lock function of the heater is in non-locked or locked status. Please read the instructions carefully and then continue to operate the heater.



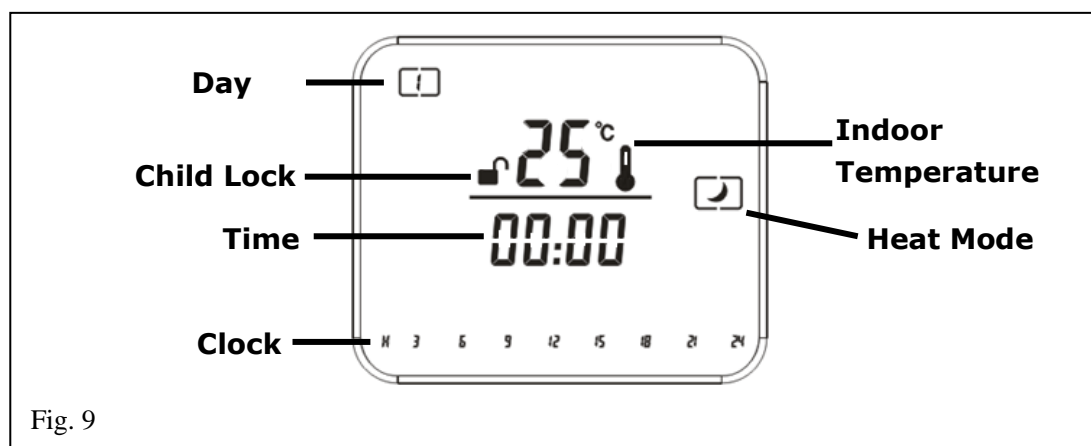

"⏻/🔒" Switch/ Child Lock Button

1. If the lock status displays  symbol, press the "⏻/🔒" button to turn the heater on.
2. If the lock status shows  symbol, press "⏻/🔒" button for 3 seconds, the child lock function is now un-locked, the screen shows  symbol, then press "⏻/🔒" button to turn on the heater.
3. When the heater is first operated, the screen shows the day, the child lock status, indoor temperature, heating mode and time. (See fig.9)







4. After the setting of the heater time cycle function (please see fig.13), press "⏻/🔒" button for 3 seconds, the child lock function will be activated, the screen shows  symbol. When the heater is locked you cannot operate the heater or press any key. If you need to unlock press "⏻/🔒" button for 3 seconds, the child lock function will turn off, and the screen will be display  symbol, and the heater can be reset.

Setting the Heating Mode "M" Mode Button







1. Press "M" button and choose the required heating function from the following 3 modes: Comfort mode , Economy mode , Frost-free mode .
2. When the heater is turned on the screen will display the  symbol, the economy

mode starts automatically as the default setting.

3. Under the economy mode, press “” button once and the  symbol will illuminate, Comfort mode starts.

4. Under the Comfort mode press “” button,  symbol will illuminate, Frost-free mode starts.

Note:

If the screen displays  and  symbols or  and  symbols at the same time this indicates that the heater is in heating status. After reaching the preset temperature, the screen only display  or  symbol, the heater is in standby.

Setting the Temperature “▲” and “▼” Buttons

1. The temperature setting range of the heater is 5°C to 50°C. In the comfort mode or economy mode, use the “▲” or “▼” button to select the desired indoor temperature.

2. Press the “▲” or “▼” button the temperature figure will start to flash, now select the temperature you need.

3. Once you have reached your desired temperature setting, press the “” button to save the setting or wait for 10 seconds and the heater will automatically save the temperature setting.

Note:

After the heater reaches the preset temperature, the screen will no longer show  symbol. The heater is in standby mode.

The preset temperature for frost-free mode is 5°C, in this mode, the default temperature is not adjustable.

Setting the Time & Day

1. Press and hold the “▲” button for 3 seconds, around the border of the screen the “day number” will flash. Press the “▲” and “▼” button to set current day.

Note: 1 is Monday, through to 7 which represents Sunday.

2. Once the correct day is selected press "▲" button twice for 3 seconds, the hour number will start to flash. Press the "▲" and "▼" button to set current hour.
3. Now press "▲" button three times for 3 seconds, the minute number will flash, press the "▲" and "▼" button to set current minute.
4. When you have finished selecting the day and time , press the "⏻/🔒" button to save the Settings, or wait for 10 seconds, and the heater will automatically save the time setting.

Setting a Personalised Heating Program 🕒 Program Button

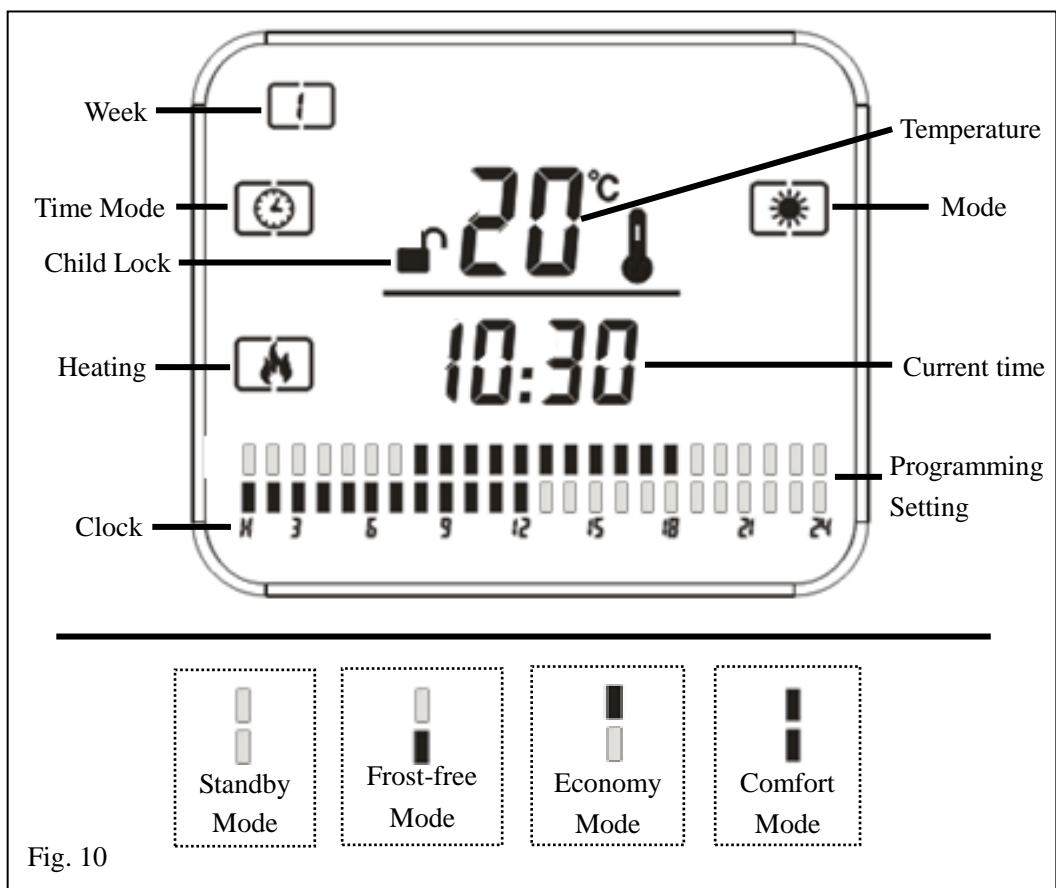





Fig. 10

1. Press the "🕒" Button and the "Prog" symbol and "Day" icon will light up on the display. Press "▲" and "▼" button to set the required day.
2. After setting the Day, press the "🕒" button again, the hour number will flash on the

screen. Press "▲" and "▼" button to set the time for programming.

3. After setting the time, press the "M" button to select the type of heating mode you require for that selected time. You can choose one of four modes: Comfort mode , Economy mode , Frost-free mode  and Standby mode.

4. After you have finished setting the program for this time press the "⏻/🔒" button to save the Settings, or wait for 10 seconds and the heater will automatically save your setting.

5. Repeat the above 1-4 steps to complete your full 24-hour personalised setting.

6. Repeat the above process for each day of the week.

7. Once you have finished personalising the full week press the "🕒" button for 3 seconds, the "P0" will flash on screen, press the "⏻/🔒" button to save the full program, or wait for 10 seconds, and the heater will automatically save the setting.

8. To start your program press the "M" button and the timer function starts. The  icon will illuminate on the screen.

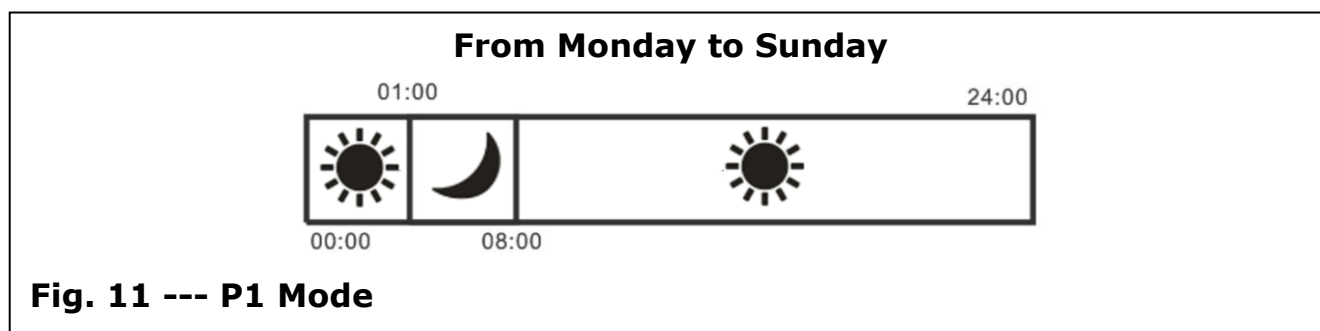

Note: This heater is also preloaded with 3 automatic heating programs (P1/P2/P3). To activate any of these programs simply select (P1/P2/P3) alternatively to P0 when selecting a program. (Fig 11, Fig 12 & Fig 13)

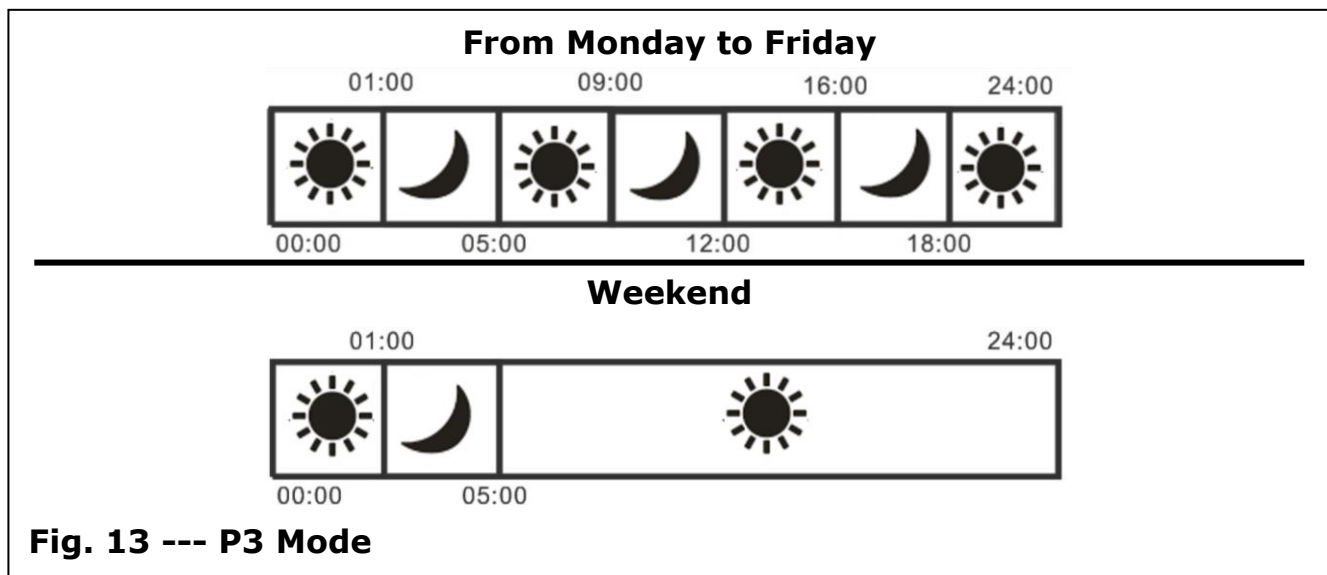
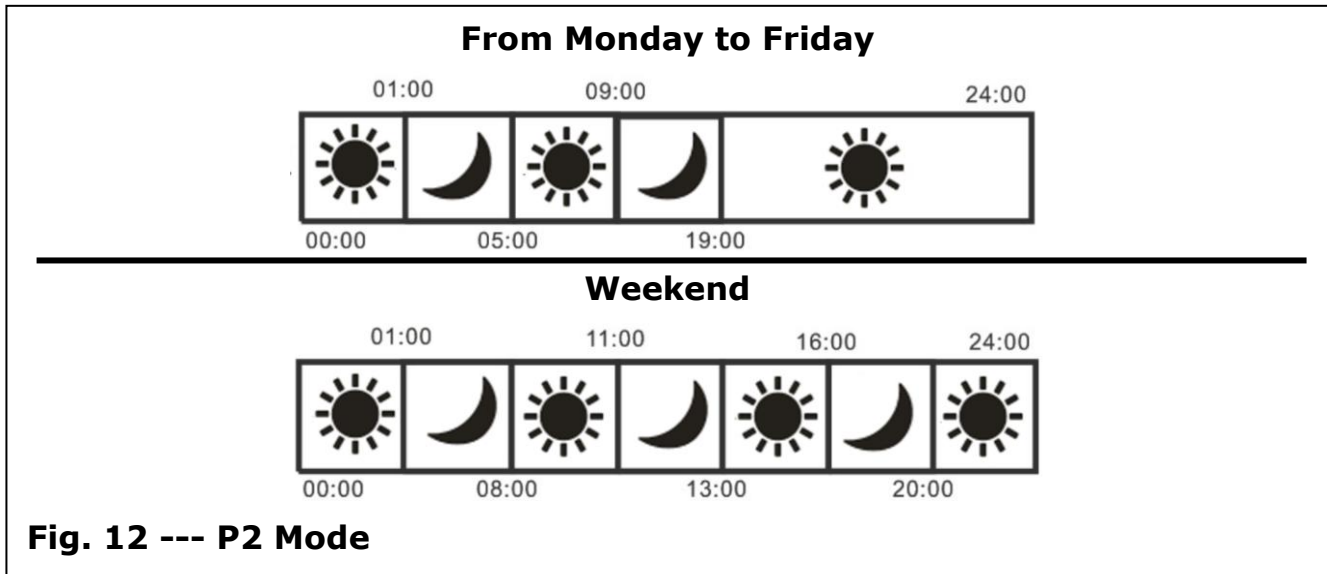





Heating Modes Explained

1. **Comfort mode:** When the room temperature reaches 2 degrees lower than the pre-set temperature on the heater, the heating will switch on. The ☀️ icon will display on screen. Once the room temperature reaches 2 degrees above the pre-set temperature the heating switches off. The 🌙 icon will now cease to display.

2. **Economy mode:** When the room temperature reaches 4 degrees lower than the pre-set temperature on the heater, the heating will switch on. The  icon will display on screen. Once the room temperature reaches 4 degrees above the pre-set temperature the heating switches off. The  icon will now cease to display.
3. **Frost-free mode:** In this heating mode the heater only switches itself on when the heater reaches a temperature of 5 degrees. Once the temperature reaches 7 degrees the heater will automatically turn its self-off.

Resetting the Heater

In the event you would like to clear any personalised settings or programs simply push and hold the “” and “” buttons together for 3 seconds. This will then delete all personalized programs you may have set.

Open Window Detection

This is an automatic built in function which if the heater detects a sudden drop of 5 degrees or more in room temperature it switches itself off to save power. Usually this sort of sudden drop in temperature can only be caused by an open window or door.

Disposal



Disposal of product

Products with this symbol may not be disposed of with the household waste. You are obliged to dispose of such units separately.

■ Contact your community authorities for information regarding the correct disposal of the product.

By disposing of the product correctly you are ensuring that it will be recycled or processed for reuse. This helps to prevent hazardous material from damaging the environment.

Disposing of the packaging

The packaging is made of cardboard and separately labelled foil which is also recyclable. Take these materials to a recycling centre.

Declaration of Conformity

The declaration is to certify that it conforms to CE, EMC, LVD and RoHS directives:

EN55014-1/A2: 2011

EN55014-2/A2: 2008

EN61000-3-2: 2014

EN61000-3-3: 2013

All provisions of Annex 1 of Council Directive 2014/30/EU – EMC directive

EN60335-1: 2014

EN60335-2-30/A11: 2012

EN62233: 2008

All provisions of Annex 1 of Council Directive 2014/35/EU – the Low Voltage Directive

RoHS 2011/65/EU



A handwritten signature in black ink, appearing to read 'Paul Kaye'.

Mr. Paul Kaye, UK QA Manager

Please read the following carefully

FUTURA Direct Ltd. and/or its distributor have provided the parts list and assembly diagram as a reference tool only. Neither FUTURA Direct Ltd. nor its distributor makes any representation or warranty of any kind to the buyer that he or she is qualified to do any repairs or replace any parts of this product. FUTURA Direct Ltd. and its distributor expressly state that all repairs or parts replacement should be done by certified or licensed technicians. The buyer assumes all risk and liability arising out of his or her repairs or parts replacement to the original product.

24 Months Limited Warranty

If within 24 months from the date of purchase you experience any problems with your product, please return the product to its distributor/dealer for repair or replacement. This warranty DOES NOT COVER normal wear, or any damage as a result of accidents, misuse, abuse or negligence.

REGISTER YOUR GUARANTEE

www.futura-direct.co.uk/guarantee

Contact us at www.futuradirect.co.uk/contact

Register at www.futura-direct.co.uk/guarantee

We FUTURA Direct Ltd, England DN6 7AY declare that the panel heater is exclusively manufactured for Futura Direct Ltd and has been manufactured according to our full quality assurance procedures.